

AUTOMOTIVE

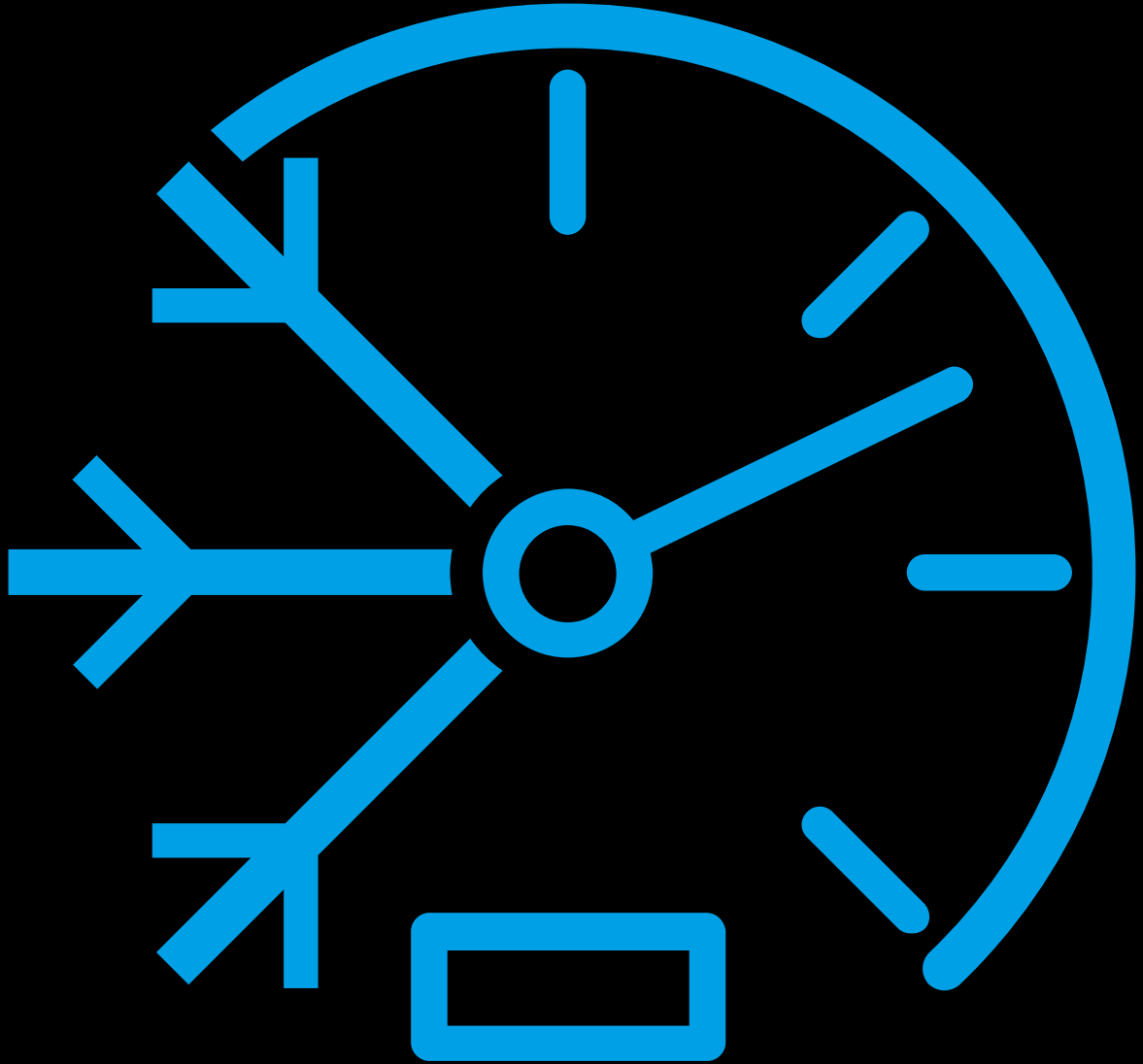

2024

Environmental Sustainability.

Not a destination.

A journey to experience.

Awarded for the second time as one of the 100 most sustainable Italian companies by Forbes, Errecom renews with the same enthusiasm its commitment to sustainability.

Increase in eco-friendly products in support of a circular economy.
Replacing plastic packaging with recycled cardboard.
Use of recycled plastic when the formulation allows it.
Dematerialisation of technical and information material.



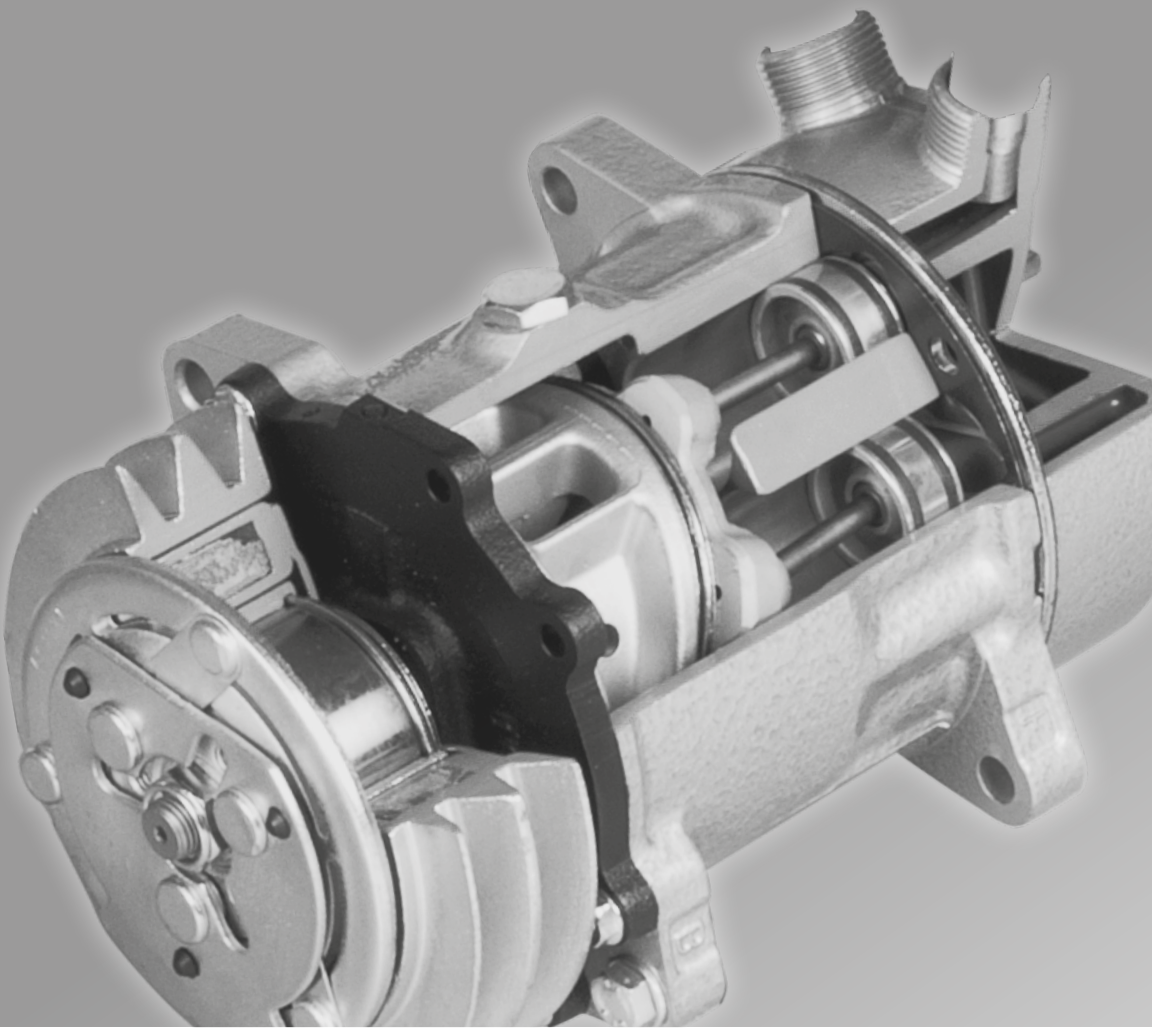



Compressor+

Additiv for A/C kompressor ved bytte eller skylling av A/C system

- Gjenoppretter de optimale arbeidsforholdene til kjøretøyets klimaanlegg etter utskifting av kompressor eller spyling av kretsen.
- Eliminerer og nøytraliserer alle partikler og forurensninger som potensielt er farlig for nylig spylte systemkomponenter. Disse inkluderer fuktighet, tung spylevæskerester og forurensninger som flussyre, saltsyre og Karbonsyrer som utvikler seg som følge av forfall av kjølemiddelgass og smøremiddel forårsaket av de høye temperaturene som kompressoren når i tilfelle den brenner eller svikter.
- Eliminerer risikoen for kretsskader etter at kompressoren er skiftet ut eller at kretsen har spylt.
- Sikker for klimaanleggskomponenter.
- Kompatibel med alle kjølesmøremidler.
- Kompatibel med alle kjølemiddelgasser.

Art.-Nr.	Beskrivelse	€		
TR1162.AL.01.S2	Doser på 6 mL (0.25 Fl oz)	-	30	5400

  6 mL





Extreme Ultra

Kun 6 ml lekkasje stopper skal til for A/C system R134a & R1234yf

Hva er det?

EXTREME ULTRA er den ultimate lekkasjestopper som løser alle problemer knyttet til små gass lekkasjer i A/C systemer. Etter mer enn 4 år og mer en 1000 tester, har Errecom fått frem en 6 mL dose lekkasjestopper som kan arbeide med alle typer kjølegasser inkludert R32 & R1234yf, EXTREME ULTRA 6ml med ny formel behandler A/C og kjøle systemer til 21KW (6 tonn).

EXTREME ULTRA lokaliserer gasslekkasjer og tetter de permanent, uten å reagere på fuktighet og oksygen.

EXTREME ULTRA er en polymer (plast) fri løsning som reparerer lekkasjer opptil 0,3 mm.

Fordeler

- Kun 6 ml kan behandle lekkasjen i A/C systemet opptil 21 KW (6 ton).
- Ny avansert formel. - Mindre væske skal legges til A/C systemet.
- Stopper lekkasje permanent i metal og gummi komponenter i A/C systemet.
- Trygg å bruke skader ikke A/C systemet.
- Ufarlig for servicestasjonen.
- Reagerer ikke på fuktighet.
- Polymer-fri. - Synlig med UV lampe.
- Ikke brennbar, irriterer ikke, sikker for tekniker.
- Kompatibel med kjølegassene R134a & R1234yf
- Reduserer kompressor støy.
- Ideell for forebyggende vedlikehold.
- *For kjøretøy A/C system opptil 6,0 Kg - 13.2 lb kjølegass.*

Art.-Nr.	Beskrivelse	€		
TR1163.AL.H2.S2	Doser på 6 mL (0.25 fl oz)	-	30	5400

6 mL



FixQuick

Ultra rask Lekkasje stopper



- Ultra rask bruker kun 20 sekunder på å forsegle kjølegass lekkasje på inntil 1 mm.
- Kan også brukes på kjøleradiatore, forseglr lekkasjer på inntil 1 mm.
- Etter 20 sekunder motstår trykk opptil 20 bar.
- Etter 20 minutter trykk opptil 50 bar.
- Tåler temperatur på 250 gr C.
- Enkel i bruk: STEP 1; Væske med kost STEP 2; Pulver.
- Kan brukes på metall og plast komponenter.
- Kan brukes på flate eller buede overflater.
- Synlig med UV lampe.

Art.-Nr.	€		
TR1241.01	-	30	-

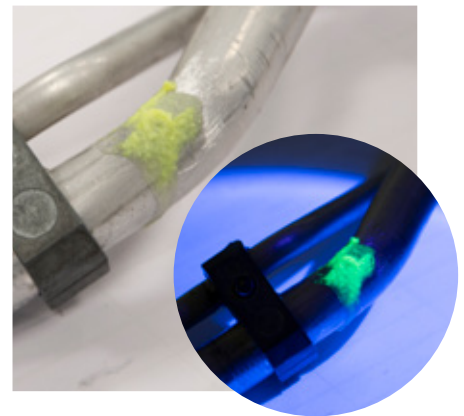
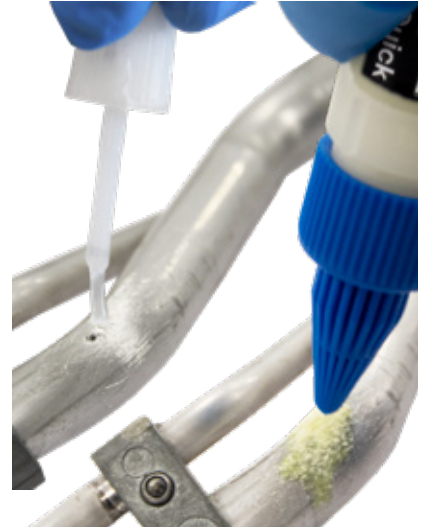

External

To komponent lekkasje stopper

Hva er det?

External er en lekkasje stopper som påføres utvendig på kjøretøyets A/C komponenter. Spesielt designet for å effektivt forsegle alle typer lekkasjer opptil 5 mm på metall komponenter i et system, Eksternal er motstandsdyktig mot smøremidler, tilsetningsstoffer og kjølegasser.

Motstår temperatur svingninger og kan brukes både på siden av høy og lav trykksiden.

- Den kan brukes på metall komponentene i systemet som kobber, aluminium og stål.
- Den kan brukes på termoplastisk rør.
- Det motstår mineral smøremidler, POE, PAG, PAO og alkyl benzen.
- Det motstår kjølemediet gassene KFK, HFK, HKFK, CO2, R32 og R1234yf.
- Den er motstandsdyktig mot rensesvæsker og klorerte væsker.
- Den tåler et temperaturområde fra -100 ° C til + 270 ° C.
- Trykk motstanden avhenger av størrelsen på lekkasjen:
 - 5 mm = 40 bar
 - 2 mm = 50 bar
 - 1 mm = 57 bar

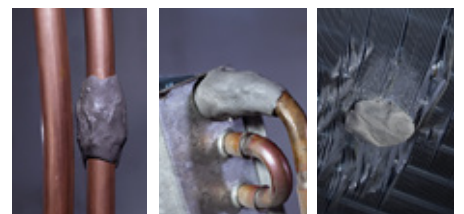

Art.-Nr.	€		
TR1166.01	-	60	10800



Cool-Shot Ultra

Ytelses forbedrer for A/C systemer

Hva er det?

COOL-SHOT ULTRA er en syntetisk katalysator som forbedrer effektiviteten på aircondition systemer og reduserer CO₂-utslipp. Errecom laboratoriet har økt sin egen Ultra samling: Cool-Shot Ultra-formulering er faktisk redusert til bare 6 mL, kan behandle systemer opp til 21 kw | 6 tonn.

Hvordan virker det?

COOL-SHOT ULTRA består av to katalysatorer og et smøremiddel som gjør det mulig for klimaanlegget kan arbeide med maksimal effektivitet: kun 6 ml produkt kan eliminere Olje fouling fenomen.

Fordeler

- Bare 6 mL av produktet kan behandle systemer opptil 21 kw | 6 tonn
- Gjenoppretter de opprinnelige forholdene i eldre A / C-systemer
- Forbedrer varmeoverføring opptil 76%.
- Øker Kjøle kapasitet med 30-40%.
- Leverer kjøligere luft ut vent dyse luft (ca 2-3°C) raskere
- Økning på 62% smøreevne av kompressoren smøremiddel.
- Reduserer kompressor friksjon, med en påfølgende reduksjon av vibrasjon og støyreduksjon.
- Forlenger livet til systemet med 70-80%.
- Reduserer årlige vedlikeholdskostnader med ca 20%.
- Reduserer karbonmonoksid utslipp.
- Synlig for UV-lampe.

Art.-Nr.	Beskrivelse	€		
TR1170.AL.H2.S2	Doser på 6 mL (0.25 fl oz)	-	30	5400

6 mL



Super-Dry Ultra

Anti fuktighet additiv

Eliminerer permanent fuktoppbygging inne i kjøretøyets klimaanlegg takket være spesiell kjemisk formel som trekker ut vann fra kjølesmøremiddelet.

- Endrer ikke kjølemiddelgasser.
- Sikker for pakninger og systemkomponenter, kompressor og klimaanlegg.
- Svekker ikke kraften i systemet, og det endrer heller ikke ytelsen.
- Kompatibel med alle kjølesmøremidler.
- Det profesjonelle valget for forebyggende vedlikehold: eliminerer fuktighet, det hemmer syre dannelse over tid.
- *Kompatibel med hybrid- og elbiler.*

Art.-Nr.	Beskrivelse	€		
TR1174.AL.H2.S2	Doser på 6 mL (0.25 fl oz)	-	30	5400

6 mL



No-Acid Ultra

Syre nøytraliser additiv

- Eliminerer alle syreforurensninger (forårsaket av nedbrytning av kjølemiddelgass eller smøremiddel, samspillet mellom den ekstra fuktigheten og smøremiddelet, eller kompressorfeilen) fra kjøretøyets klimaanlegg.
- Forhindrer kompressorbrudd.
- Sikker for systemkomponenter og klimaanlegg.
- Kompatibel med alle kjølesmøremidler.
- Det profesjonelle valget for forebyggende vedlikehold: det forhindrer at syre utvikler seg over tid.
- *Kompatibel med hybrid- og elbiler.*

Art.-Nr.	Beskrivelse	€		
TR1175.AL.H2.S2	Doser på 6 mL (0.25 fl oz)	-	30	5400



6 mL



Plastic Straight Adapters

Art.-Nr.	Description	€	
RK1422.S1	Pack containing (A) + (B)	-	30
RK1423.S1	Pack containing (A) + (C)	-	30

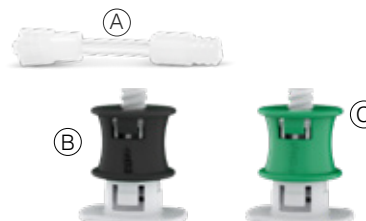

Plastic Straight Adapters with Metal Valve

Art.-Nr.	Description	€	
TB5162.01	R134a Adapter (E)	-	20
TB5163.01	R1234yf Adapter (G)	-	20





Oljer til kjøretøyets klimaanlegg er i dag et komplekst bilde, det er svært viktig å bruke korrekt olje i forhold til type kompressor, mekanisk/elektrisk, type kjølegass. Errecom produserer oljer med høy kvalitet og til alle typer klimaanlegg. PAG olje for mekaniske kompressorer, men også til elektriske, men da med **SPA2** spesifikasjon som betyr at oljen er isolert.

PAG oljen leveres som Double End Capped, møter spesifikasjon for OE

POE100 Hybrid er olje for elektriske kompressorer for R134a / R1234yf

POE olje 55 og 68 ofte brukt A/C anlegg på buss.

PREMIUM PAG Olje

PREMIUM PAG er syntetiske smøremidler basert på polyalkylenglykoler, spesielt designet for klimaanlegg i kjøretøy som bruker R12, R134a og R1234yf. Takket være kvaliteten på deres doble formel og høyttelsesadditiver spesielt designet for bilindustrien, Premium PAG-smøremidler setter standarden for kompressormøring av alle klimaanlegg.

Errecoms PREMIUM PAGs er preget av:

- dobbel-end-capped teknologi: det garanterer utmerket kjemisk og termisk stabilitet;
- utmerkede smøreegenskaper selv under ekstreme trykk og høye temperaturforhold;
- optimalisert blandbarhet med R12, R134a og R1234yf: det garanterer riktig oljeretur til kompressoren, sikre maksimal systemeffektivitet;
- lav hygroskopisitet: det sikrer lavere vannabsorpsjon enn standard PAG;
- Høy viskositetsindeks, lavt hellepunkt og utmerket langtidssmøring.

Physical Quantity Measured (Unit of Measurement)	Analytical Reference Method	PREMIUM PAG	PREMIUM PAG 46	PREMIUM PAG 100	PREMIUM PAG 125	PREMIUM PAG 150
ISO VG	-	68	46	100	125	150
Kinematic Viscosity @ 40°C (cSt)	ASTM-D445	68	46	100	125	150
Kinematic Viscosity @ 100°C (cSt)	ASTM-D445	12,4	8,6	21	21	25
Viscosity Index	ASTM-D2270	181	184	225	199	200
Pour Point (°C)	ASTM-D97	-40	-43	-40	-42	-40
Flash Point (°C)	ASTM-D93	215	226	230	215	230
Density @ 15°C (g/cm ³)	ASTM-D1298	0,999	0,999	0,993	1	1,005
Moisture Level (ppm)	ASTM-D6304	300	300	300	300	300
Total Acid (mg KOH/g)	ASTM-D974	0,05	0,05	0,05	0,05	0,05

A/C Kompressor olje

PREMIUM PAG

Art.-Nr.	Beskrivelse	€		
OL6057.M.P2	500 mL (17 fl oz) flaske	-	12	1080

PREMIUM PAG 100

Art.-Nr.	Beskrivelse	€		
OL6003.Q.P2	250 mL (8.5 fl oz) flaske	-	24	2880

PREMIUM PAG 150

Art.-Nr.	Beskrivelse	€		
OL6005.Q.P2	250 mL (8.5 fl oz) flaske	-	24	2880

PREMIUM PAG 46

Art.-Nr.	Beskrivelse	€		
OL6001.Q.P2	250 mL (8.5 fl oz) flaske	-	24	2880

PREMIUM PAG 125

Art.-Nr.	Beskrivelse	€		
OL6004.Q.P2	250 mL (8.5 fl oz) flaske	-	24	2880

HFO – PAG Oljer (R1234yf)

HFO - PAG smøremidler er polyalkylenglykolbaserte smøremidler spesielt formulert og utviklet for bruk med R1234yf i klimaanlegg i kjøretøy. Dobbeltbindingen i molekylstrukturen til R1234yf gjør dette kjølemediet mye mer kjemisk reaktivt enn R134a.

Formuleringen av HFO - PAG løser dette problemet og maksimerer blandbarheten til HFO.

Nettopp av denne grunn skiller ERRECOMs HFO - PAGs seg fra standard PAGs som brukes med R134a av forskjellige faktorer.

- Den grunnleggende kjemiske strukturen til smøremiddelet, som i tilfelle av HFO - PAG er en dobbel-end-capped PAG, mens i tilfelle av PAG for R134a det er single-end-capped.
- Additivpakken som brukes, for å sikre den langsiktige ytelsen til HFO - PAG, er utviklet i henhold til driftsforhold som kreves av HFO - PAG ved drift med R1234yf.

Errecoms HFO - PAG er karektaristisk:

- PAG-teknologi med double-end capped og optimalisert blandbarhet i HFO-R1234yf: det sikrer full systemeffektivitet;
- tilsetningsstoffer med høy ytelse: de sikrer bedre termisk, kjemisk og hydrolytisk stabilitet i kjøretøyets klimaanlegg;
- lavere vannabsorpsjon sammenlignet med klassiske PAG-er: Det forbedrer påliteligheten og holdbarheten til systemet.

Physical Quantity Measured (Unit of Measurement)	Analytical Reference Method	HFO - PAG 46	HFO - PAG 100
ISO VG	-	46	100
Kinematic Viscosity @ 40°C (cSt)	ASTM-D445	46	100
Kinematic Viscosity @ 100°C (cSt)	ASTM-D445	10	20
Viscosity Index	ASTM-D2270	213	212
Pour Point (°C)	ASTM-D97	-49	-41
Flash Point (°C)	ASTM-D93	220	230
Density @ 15°C (g/cm³)	ASTM-D1298	0,999	1,002
Moisture Level (ppm)	ASTM-D6304	300	300
Total Acid (mg KOH/g)	ASTM-D974	0,04	0,04

HFO - PAG 46

Art.-Nr.	Beskrivelse	€		
OL6047.Q.P2	250 mL (8.5 fl oz) flaske	-	24	2880

HFO - PAG 100

Art.-Nr.	Beskrivelse	€		
OL6048.Q.P2	250 mL (8.5 fl oz) flaske	-	24	2880



CO₂ PAG Oljer

Errecoms CO₂ - PAGs kjennetegnes av:

- Teknologi med double-end teknologi og optimalisert blandbarhet med CO₂: Den maksimerer oljetilbakeføringen til kompressoren for å sikre full systemeffektivitet, uten tap av hydrodynamiske eller smøreegenskaper;
- utmerkede smøreegenskaper selv under ekstreme trykk og høye temperaturforhold;
- Tilsetningsstoffer med høy ytelse: De sikrer utmerket termisk, kjemisk og hydrolytisk stabilitet, og reduserer nedetid og vedlikeholdskostnader;
- lav hygroskopisitet: det sikrer lavere vannabsorpsjon enn alternative R744-teknologier (POE, PAO, Alkylbenzenes);
- kompatibilitet med metall- og plastkomponenter: det sikrer optimal systemstabilitet og holdbarhet;
- Høy viskositetsindeks og lavt hellepunkt: de garanterer systemets fulle effektivitet og utmerkede smøreegenskaper til og med under ekstremt press.

Physical Quantity Measured (Unit of Measurement)	Analytical Reference Method	CO ₂ - PAG 68
ISO VG	-	68
Kinematic Viscosity @ 40°C (cSt)	ASTM-D445	70
Kinematic Viscosity @ 100°C (cSt)	ASTM-D445	14
Viscosity Index	ASTM-D2270	210
Pour Point (°C)	ASTM-D97	-46
Flash Point (°C)	ASTM-D93	> 200
Density @ 15°C (g/cm ³)	ASTM-D1298	0,998
Moisture Level (ppm)	ASTM-D6304	300
Total Acid (mg KOH/g)	ASTM-D974	0,02

CO₂ - PAG 68

Art.-Nr.	Beskrivelse	€		
OL6076.Q.P2	250 mL (8.5 fl oz) flaske	-	24	2880

E-POE Oljer



Errecoms POEer er syntetiske smøremidler spesielt utviklet for elektriske kompressorer. De består av en blanding av polyolestere og tilsetningsstoffer som er nøye utvalgt for å oppnå bedre smøreevne sammenlignet med vanlige POEer, god kjemisk og termisk stabilitet og utmerket slitasjebeskyttelse for komponentene i klimaanlegget i hybrid- eller elbiler. E-POE er spesielt egnet for ikke-ozonnedbrytende kjølemidler som FC og HFC (R134a, R404a, R507, R410a, R407c). De er også kompatible med hydrokarbonkjølemidler og HFO-kjølemidler som HFO-1234yf og HFO-1234ze. De er kjennetegnes ved optimal blandbarhet med slike kjølemidler selv ved de laveste temperaturene. Errecoms E-POEer kjennetegnes av:

- forgrenet POE-teknologi: det sikrer kjemisk stabilitet i kjøretøyets klimaanlegg;
- Lavt fuktighets- og syreinnhold: Det minimerer syrekost i løpet av systemets levetid;
- Utmerkede elektriske isolasjonsegenskaper: det gjør klimaanlegget egnet for bruk
- i hermetisk forseglede systemer.

Physical Quantity Measured (Unit of Measurement)	Analytical Reference Method	E-POE 100
ISO VG	-	100
Kinematic Viscosity @ 40°C (cSt)	ASTM-D445	100
Kinematic Viscosity @ 100°C (cSt)	ASTM-D445	11
Viscosity Index	ASTM-D2270	110
Pour Point (°C)	ASTM-D97	-36
Flash Point (°C)	ASTM-D93	300
Density @ 15°C (g/cm ³)	ASTM-D1298	0,965
Moisture Level (ppm)	ASTM-D6304	75
Total Acid (mg KOH/g)	ASTM-D974	<0,04
Electrical resistivity/ electrical conductivity (Ω-cm)	ASTM-D2624	160
Total Acid (mg KOH/g)	IEC 60156	>75

E-POE 100

Art.-Nr.	Beskrivelse	€		
OL6033.Q.P2	250 mL (8.5 fl oz) flaske	-	24	2880

UV Sporstoff



UV sporstoff gir rask og nøyaktig oppdagelse av lekkasje punktet i kjøretøyets klimaanlegg. Bruk av UV lampe og briller viser raskt hvor lekkasjen er.

- Passer til R12 – R134a – R1234yf og elektriske kompressorer.
- Inneholder ikke løsemidler.
- Samsvarer med SAE J2297 og SAE J2298.
- Sikker for klimaanlegg eller gjenvinningsstasjoner.
- Endrer ikke kjølesmøremiddelet.
- Kompatibel med alle kjølesmøremidler.
- Fargestoffdetekterte etiketter inkludert.



Green Brilliant Grønn UV sporstoff for kjøretøy A / C-systemer

7,5 mL (1/4 fl oz) sprøyter i forpakning

Art.-Nr.	Beskrivelse	€		
TR1059.A6.H2.S2	Forpakning på 6 sprøyter med adapter R134a + R1234yf	-	12	1120



Selv-måle flasker

Art.-Nr.	Beskrivelse	€		
TR1033.01.S1	350 mL (11.9 fl oz) selv-måle flasker	-	12	1536





Red Brilliant Rød UV sporstoff for kjøretøy A / C-systemer

7,5 mL (1/4 fl oz) sprøyter i forpakning

Art.-Nr.	Beskrivelse	€		
TR1098.A6.H2.S2	Forpakning på 6 sprøyter med adapter R134a + R1234yf	-	12	1120

Selv-måle flasker



Art.-Nr.	Beskrivelse	€		
TR1098.O.S1	350 mL (11.9 fl oz) selv-måle flasker	-	12	1536



Best Bubbles Fluo

Fluorescerende kjølemiddelgass detektor

- Oppdager mikrolekkasjer på klimaanlegg og kjølemiddelledninger takket være den høye adhesjonskraft til overflater.
- Rask, klar og enkel å bruke.
- Driftstemperatur: fra -40 °C til + 80 °C (fra -40 °F til + 176 °F).
- Ideell i situasjoner med dårlig sikt. Lekkasje resulterer i store, tykke og fluorescerende bobler, synlige når de utsettes for UV-lamper.
- Også tilgjengelig med retningsbestemt dispenseringsutløser (A).
- Aerosolbeholderne kan brukes selv opp ned takket være den spesielle 360°-ventilen.

Art.-Nr.	Beskrivelse	€		
AB1251.N.01	Best Bubbles Fluo Aerosol	400 mL	-	12 1344
AB1251.N.01.C	Best Bubbles Fluo Aerosol (A)	400 mL	-	12 1344



POE ↔ PAG Id

Test for å sjekke typen kjølesmøremiddel inne i et AC/R-system

Hva er det?

POE ↔ PAG Id er en essensiell test for å identifisere hvilken type syntetisk smøremiddel som brukes i kjøle- og klimasystemet som skal behandles. Hvis du arbeider med et smøremiddel som er av ukjent type og opprinnelse, er bruken av POE ↔ PAG Id sterkt anbefalt: denne testen garanterer identifikasjon av olje kategorien i bruk (enten POE eller PAG) på en rask og effektiv måte.

Hvordan virker det?

Når den kommer i kontakt med smøremiddelet, inneholder POE ↔ PAG Id kjemisk elementer som reagerer ved å endre aspektet av løsningen. Resultatet vil vise om det er POE eller PAG. Ta en prøve av oljen og drypp noen dråper i test glasset som inneholder en væske. Er det PAG olje forblir væsken klar er det POE blir væsken gråaktig.

Fordeler:

Reagerer på alle POE og PAG oljer. – Resultatet vises etter noen sekunder.
Enkel i bruk. – Settet inneholder 4 test glass.

Art.-Nr.	€		
RK1411.S1	-	12	2160



Oil Guard

Visuelt diagnose glass for kontroll av A/C system



Oil Guard er et diagnose verktøy for å bekrefte den generelle tilstanden til A/C systemet, bare ved å koble til høyt og lavt trykks porter på A/C systemet. Gjennom Oil Guard glasset er det mulig å visuelt inspisere tilstedeværelsen av kjemiske tilsetninger som UV sporstoff eller A/C lekkasje stopper, samt olje/kjølemediet gass blandbarhet.

Det er derfor mulig å vurdere kvaliteten på oljen, og mulige tilstedeværelse av vann eller andre forurensninger.

Oil Guard inkluderer:

100 cm rød fylleslange. - 100 cm blå fylleslange.

Lavtrykk hurtig kopligng. - Høytrykk hurtig kopligng.

Art.-Nr.	Beskrivelse	€		
RK1268	Oil Guard R134a	-	01	-
RK1025	Oil Guard R1234yf	-	01	-





Easy Gun

Injection System for 240 mL Cartridges

EasyGun er Errecoms verktøy for å sprøyte inn 240 m patroner med tilsetningsstoffer, UV sporstoff, og smøremidler i AC/R-systemer.

Art.-Nr.	Beskrivelse	€	♻️
IN1032.01	EasyGun	-	01
TB5201.01	R134a Adapter	-	01
TB5202.01	R1234yf Adapter	-	01



Fluorescerende UV-sporstoff for A/C systemer

Art.-Nr.	Beskrivelse	€	♻️	♻️
TR1059.DQ.01	Green Brilliant - 240 mL (8 fl oz)	06	-	-
TR1098.DQ.01	Red Brilliant - 240 mL (8 fl oz)	06	-	-



PAG olje for A/C systemer

Art.-Nr.	Beskrivelse	€	♻️	♻️
OL6057.DQ.01	Premium PAG - 240 mL (8 fl oz)	-	06	-
OL6001.DQ.01	Premium PAG 46 - 240 mL (8 fl oz)	-	06	-
OL6003.DQ.01	Premium PAG 100 - 240 mL (8 fl oz)	-	06	-
OL6005.DQ.01	Premium PAG 150 - 240 mL (8 fl oz)	-	06	-

POE olje for A/C systemer

Art.-Nr.	Beskrivelse	€	♻️	♻️
OL6033.DQ.01	E-POE 100 - 240 mL (8 fl oz)	-	06	-

Special Bag System

Hva er det?

Errecoms Special Bag system har blitt spesielt designet for å unngå fuktighet og partikkel forurensning av smøremidler og fargestoffer som brukes i A/C systemer. Errecom's høy kvalitets UV sporstoff og Double End cap olje fylles i laminerte poser som holder fuktigheten ute og leveres med hurtig kobling for bruk på service stasjoner for klimaanlegg.

Hvordan virker det?

Koble Errecom's spesial kobling til hvilken som helst servicestasjon, fest posen til koblingen og forsett med servicen.

Fordeler

- Ingen fuktighet
- Ingen forurensinger
- Ikke noe søl eller bort kastet tid som ved fylling av olje beholder.
- Ingen ekstra kostnader - samme kostnad som for standard forpakning.
- Enkel i bruk.
- Kan brukes på nesten alle servicestasjoner på markedet.
- Gir rask, enkel og rent vedlikehold.
- Unngår fuktighet og andre urenheter å komme inn servicestasjonen.
- Sikker og fukt fri lagring.



A/C Sporstoff for Kompressor

Art.-Nr.	Beskrivelse	€	☑	☑
TR1021.SH	Green Brilliant - 150 mL (5 fl oz)	-	01	-
TR1098.SH	Red Brilliant - 150 mL (5 fl oz)	-	01	-

Errecom Oljer

Art.-Nr.	Beskrivelse	€	☑	☑
OL6057.SH	PREMIUM PAG - 150 mL (5 fl oz)	-	01	-
OL6033.SH	E-POE 100 - 150 mL (5 fl oz)	-	01	-
OL6001.SH	PREMIUM PAG 46 - 150 mL (5 fl oz)	-	01	-



Spesial adapter for Special Bag System

Art.-Nr.	Beskrivelse	€	☑	☑
RV5999.88	Yellow special connection 1/8" Hunn	-	01	-
RV5999.93	White special connection 1/8" Hunn	-	01	-
RV5999.84	Yellow special connection 1/8" Hann	-	01	-
RV5999.69	White special connection 1/8" Hann	-	01	-



Spesial adapter med hurtigkobling for Special Bag System

Art.-Nr.	Beskrivelse	€	☑	☑
RP1038.01.W	White Straight Connection	-	01	-
RP1039.01.W	90° White Connection	-	01	-
RP1038.01.Y	Yellow Straight Connection	-	01	-
RP1039.01.Y	90° Yellow Connection	-	01	-



Brilliant Remover

UV Sporstoff fjerner

Fjerner UV sporstoff fra overflater og verktøy. Når et system har blitt injisert med sporstoff eller et system reparert etter en lekkasje, Brilliant Remover kan brukes til å fjerne UV sporstoff rester fra porter og forurensede A/C system deler, dermed unngår man mulig falske avlesninger.

Art.-Nr.	Beskrivelse	€		
TR1109.01	100 mL (3.4 fl oz) - Spray flaske	-	32	-



Fleksibel Lys Lykt

- Power supply: 3 batteries "AA" of 1.5 V
- Goggles anti-UV protection
- LED wavelength: 385-380 nm
- 5 white led head
- Aluminium body

Art.-Nr.	Beskrivelse	€	
RK1267	Flexible Bright Torch	-	05
UV1002.01	UV-Briller	-	05



UV lampe 12 volt

Uv lampe som kan lokalisere lekkasjer fra A/C system. Kontrollerer alle A/C systemkomponenter, ved lekkasje vil sporstoffet fluorisere.

Technical features:

- Strømforsyning: 12 V
- UV-Briller included.
- UV-lys frekvens: 410-405 NM.

Art.-Nr.	€	
RK1231	-	05



Sporstoff / Olje Injektor

- Volum på 60 ml, kobles til lavtrykk siden, «skruv oljen inn» Refillable
- 60 mL volum
- 1/4 SAE Dreibar tilkobling
- R134a lavtrykksport med hurtig kopleing
- Plastkoffert

Art.-Nr.	€	
RK1155	-	01



N₂H₂ Electronic Leak Detector

N₂ H₂ ELEKTRONISK LEKKASJESØKER er en elektronisk enhet designet for å oppdage en 5% hydrogen (H₂) + 95% nitrogen (N₂) gassblanding og følgende kjølemiddelgasser: R134a - R410a - R407c - R1234yf - R32 - R404a - R502 - R600 - R290. Denne lekkasjesøkeren er utstyrt med en oppvarmet sensor og en mikroprosessor som garanterer en nøyaktig og veldig presist signal. Takket være de 3 følsomhetsnivåene og 7 LED trefarget visuell skjerm, kan denne lekkasjesøkeren garantere deteksjon av lekkasjer opp til 5 ppm (2gr / år).

Tekniske egenskaper:

- Halvleder oppvarmet sensor.
- 40 cm rustfritt fleksibel sonde.
- Driftstemperatur: fra 0 °C til 40 °C.
- 3 følsomhetsnivåer.
- Lekkasjedeteksjonsindikator med 7 LED trefarget visuell skala.
- Påvisbare kjølemiddelgasser: R134a - R1234yf - R410a - R404a - R407c - R32 - R502 - R600 - R290.
- Kompatibel med SAE J1627 CE.
- Strømkilde: 2 x C størrelse alkaliske batterier.
- Strømforsyning: 3,3 V / 0,5 A.
- Plastkasse (22,2 x 6,6 x 5,1 cm).
- Vekt: 418 gr (batteri inkludert).

Art.-Nr.	€		
RK1335	-	01	-



RK1335

AS1019.01

Evaporator Cleaner Foam

Renseskum til fordampere

Renser luftkanaler, inkorporerer og fjerner forurensninger som støv, smuss, allergener og mikroorganismer som ofte forårsaker vondt lukt.

- Gjenoppretter innendørs luftkvalitet og frigjør en behagelig duft.
- Enkel å bruke takket være kanylen.
- Rask og effektiv handling. Klar til bruk. Krever ikke skylling.
- Også tilgjengelig i den skummende versjonen EVAPORATOR CLEANER FOAM, hvis formelen inkorporerer og fjerner selv de vanskeligste å nå skitt.
- HACCP-kompatibel.
- Fordamperrenseskum (N-108927).

Art.-Nr.	Beskrivelse	€		
AB1049.J.01	200 mL (6.8 fl oz) - Spray flaske	-	24	2376





Interior Purifier

Rengjørende og dypt virkende behandling for interiør

200 mL kan: renser kupeene raskt.

- Metter kupeen med rensende molekyler takket være den kontinuerlige strømning som kommer ut fra aerosolbeholderen med total frigjøring. Fjerner forurensninger fra klimaanlegg ventiler og overflater.
- Våter ikke eller etterlater merker. Ventiler kupeen etter behandlingen.
- 7 dufter tilgjengelig.
- For en fullstendig rensende virkning anbefaler Errecom å bruke første Evaporator Cleaner
- Skum og deretter interiørrenser.
- Registrert desinfeksjonsmiddel i Tyskland (N-108928).

Art.-Nr.	Beskrivelse	€		
AB1050.J.01	200 mL Mint (6.8 fl oz) - Spray boks	-	24	2376
AB1056.J.01.A	200 mL Talc (6.8 fl oz) - Spray boks	-	24	2376



Total Care

Komplett rens behandling for A/C systemer

Består av to aerosolbokser, EVAPORATOR CLEANER FOAM og INTERIOR PURIFIER, som garanterer dyp og fullstendig rensing av passasjerens rom og klimaanlegg.

- Fjerner støv, allergener og forurensninger fra bilens luftehull og overflater.
- Klar og enkel å bruke.
- Våter ikke eller etterlater merker.
- Krever ikke skylling.
- Ventiler kupeen etter behandlingen.
- 7 dufter tilgjengelig.

TOTAL CARE (Evaporator Cleaner Foam + Interior Purifier)

Art.-Nr.	Beskrivelse	€		
RKAB36.S1	200 mL Mint (6.8 fl oz) - Spray boks	-	24	-
RKAB37.S1	200 mL Talc (6.8 fl oz) - Spray boks	-	24	-



200 mL



Interior Purifier PRO

Hygienisk behandling i aerosolboks for interiør

600 mL kan: renser raskt opptil 3 kjøretøy.

- Ideell for å rense busser, lastebiler, tog, t-bane, ambulanser, cockpit, etc.
- Enkel å bruke: det tar bare 30 sekunder å rense et kjøretøy takket være høytrykksformat (20 mL / sekund).
- Fjerner og eliminerer forurensninger, støv, allergener osv.
- Klar til bruk.
- Duftende.



Art.-Nr.	€		
AB1229.U.01	-	12	1008



600 mL



Atom Machine Kit

Ultrasonic forstøver

ATOM MACHINE er en elektronisk ultralydsenhet som umiddelbart forstøver rene væske som deretter suges inn og spres via A/C systemet med resirkulering på.

En av de viktigste fordelene med Ultralyd forstøvning er muligheten til å oppnå atomiserte partikler av rensende behandling ved romtemperatur, unngå kondens som vanligvis oppstår når væsker er atomisert ved oppvarming partiklene, spredt av Atom maskinen, har en størrelse på mindre enn 5 µm derfor fester de seg ikke så lett på overflater, men er fullt overført i A/C-systemet og i det omkringliggende interiøret

Denne ytelsen kan ikke oppnås ved hjelp av tradisjonelle aerosol bokser. Størrelsen og vekten av partiklene levert av varme eller aerosol forårsake rask «nedbør» og kondens. En rensende behandling utført med ATOM Machine tar ca 30 minutter, apparatet stopper automatisk når behandlingen er over.

Spesifikasjoner:

- Dimensjoner: L170 x P110 x H170 mm.
- Vekt: 0.7 Kg.
- 30 minutter behandlingstid.
- 12V fra sigarett uttak.

Art.-Nr.	BeskrivelseT	€	
RK1395	Atom Kit - Mint	-	01
AB0024.G.01	Atom Ultra Mint	-	01



Flushing Fluid

Belnet Rensevæske A/C System

Hva er det?

Fast-Flush er det mest direkte, trygge og enkle løsningen for å spyle små A/C systemer og system komponenter.

Hvordan virker det?

Aerosol flasken er fylt med CO₂ for å gi Belnet renevæske en kraftfull hastighet på væsken. Leveres med en spesiell Flushing pistol/slange eller direkte med spesiell gummi kon.

Fordeler

- Klar til bruk
- Arbeidstrykk på 8-9 bar (116-130 psi)
- Opprettholder høyt trykk til flasken er tom - 3 bar (43.5 psi)
- Ikke behov for ekstra utstyr
- Behandlingen avsluttes med å bruke nitrogen for å få ut rester av renevæsken.

Art.-Nr.	Beskrivelse	€		
TR1009.U.M1	600 mL Can with Thread	-	12	1008
RP1042.01	Adapter 1/4 SAE (A)	-	01	-
RP1048.01	Pistol med slange og kuleventil (B)	-	01	-





Fast Flush Kit

Fast Flush med Nitrogen kit

Kit inneholder:

- Belnet Aerosol boks med gjenger.
- Pistol med slange og kuleventil.
- Nitrogen 950 ml one-shot patron.
- Mini 0-10 Bar trykk regulator.
- 1/4 SAE dreibart slangeadapter.
- LP R134a / R1234yf hurtig adapter.
- 1/4 SAE M x 5/16 SAE F 90° adapter.
- Koffert.

Art.-Nr.	Beskrivelse	€		
RK1457	Universal kit for vasking og flushing	-	12	1008



Alpha Flush Rensevæske A/C Flushing maskiner

Tilgjengelig:

- Rensevæske spesielt designet for å brukes med skylle maskiner
- Skader ikke komponenter i skylle maskin.
- Ikke brennbar
- **Ikke ADR**
- 1 Liter Metall flaske
- 5 Liter Metall kanne

Art.-Nr.	Beskrivelse	€		
TR1142.P.01	5 L (1.32 GAL) Metal kanne	-	02	196



Easy Flush

Skyllemaskin for Automotive A/C systemer med elektrisk pumpe.

Hva er det?

Easy Flush er en kraftig, effektiv skylle maskin med egen tank for sikker skylling av A/C systemer uansett størrelse og kapasitet. Det er den raskeste og enkleste løsningen for skylling av A/C systemer.

Tekniske spesifikasjoner:

- Strømforsyning: 230/240 V – 50/60 Hz
- 20 Liter Intern tank
- Pumpe kapasitet: 14 l/min
- Maksimalt pumpestrømmen: 0.75 Kw
- Maksimal pumpetrykk: 4,5 bar
- EPDM Pumpe pakninger
- Mekaniske inntaksfilteret
- Rask tilkobling for ekstern Nitrogen
- Eksterne betjening for reversering av skylle syklus uten og frakoble slanger
- 3 m fleksible slanger med 1/4 SAE kuleventiler
- Adaptersettet for tilkobling til ulike A/C systemer
- Utskiftbare tilkoblinger: 1/4 SAE -3/8 SAE -1/2 SAE (2 av hver type)
- Vekt: 20 Kg
- Dimensjoner: 445x300x740 mm

“Advarsel! Bruk Easy Flush kun sammen med reisevæsken Alpha Flush”

Art.-Nr.	€		
VP1027.01	-	01	-



Flushing Hook

Universalt adapter for bruk med skylle maskiner

Verktøy for å koble spyleutstyret til klimaanlegget. Den lille størrelsen letter tilkobling til klimaanlegg selv på trange steder

Tekniske egenskaper:

- Hann tilkobling 1/4" SAE.
- Størrelse: 80 x 50 mm.

Art.-Nr.	€		
RP1081.01	-	-	-







Brilliant Engine

UV Sporstoff for forbrenningsmotor

- Brillant Engine UV- sporstoff for å oppdage små lekkasjer i forskjellige motordeler og komponenter, selv under dårlige lysforhold når UV lampe brukes.
- Den innovative formuleringen, er kompatibel med alle motoroljer, hydraulikkolje, servorstyring, girolje.

Dosering:

7.5 mL (2.5 fl oz) per liter olje.

Art.-Nr.	Beskrivelse	€			
TR1203.Q	250 mL selv-måle flasker	-	13	1512	1680



Stop Up Engine

Lekkasjestopper for forbrenningsmotor

STOP UP Reparer og forhindrer små lekkasjer på gummi, syntetiske og naturlige pakninger i forbrenningsmotor, transmisjoner, hydrauliske systemer og servostyring.

- Kompatibel med alle oljer mineralsk som syntetisk.
- Kompatibel med DPF og katalysatorer.
- Tetter lekkasjer på alle typer motorer (bensin, diesel, LPG, methane).
- Lager ikke avleiringer eller tettet oljefilter.

Dosering:

60 ml pr liter olje.

Art.-Nr.	Beskrivelse	€			
TR1061.Q.P2C	250 mL Flaske	-	24	2592	2592



SKAL IKKE BRUKES PÅ
BREMSYSTEM!



Brilliant Coolant



UV sporstoff for kjølevanns radiatorer og lukkede systemer

BRILLIANT COOLANT er et fluorescerende UV-sporstoff utviklet for å oppdage små lekkasjer i kjøretøyets kjølesystem.

- Brilliant Coolant forblir aktiv og synlig når UV-lampe brukes.
- Det er helt trygt for alle kjølevæsker og forbedrer faktisk varmevekslingsytelsen.

Dosering:

30 ml pr kjøretøy

Art.-Nr.	Beskrivelse	€			
TR1201.O	350 mL selv-måle flasker	-	12	1344	1512



Bluet

Lekkasje stopper for kjølesystem

BLUET reparerer og forhindrer lekkasjer i kjøretøyets kjølesystem (radiator, rør, slanger og vannpumper)

- Reparerer små lekkasjer i pakninger, topp pakning, små sprekker i motorblokk og topplokk.
- Kompatibel med alle vannkjølte diesel, bensin og LPG motorer.
- Kompatibel med alle radiatorer, aluminium, plastikk og alle typer kjølevæske.

Dosage:

250 ml for system opptil 5 liter.

Art.-Nr.	Beskrivelse	€			
TR1041.Q.P2.A	250 mL Flaske	-	24	2592	2592



Zeus+



Kjølevanns radiator rens

ZEUS + er rensvæske utviklet for å rengjøre og gjenopprette den opprinnelige effektiviteten på kjølevann system. Anbefalt brukt før bytte av kjølevæske.

- Fjerner alle rester som olje, fett, rust, slam, etc. som akkumuleres over tid og reduserer kjølevæskens normale strømming og temperatur.
- Det er trygt for alle metall-, gummi- og plastkomponenter i kjøle-/varmesystemet. Den er kompatibel med alle kjølevæsketilsetninger og frostvæsker (med unntak av kjølevæsker med lav ledningsevne).

Dosering:

350 ml for system opptil 11,5 liter kjølesystem.

Art.-Nr.	Beskrivelse	€			
TR1258.O.01	350 mL Flaske	-	12	-	2052



DPF Flush

Diesel Partikkel Filter Cleaner

Hva er det?

En ikke-brannfarlig væske, uten suspenderte metaller, spesifikt for rengjøring av diesel partikkelfilter. Takket være sin spesielle kjemiske formulering, kan dette produktet kan trenge dypt inn i partikkelfilter, som enkelt fjerner karbon og sot rester som hindrer normal passering av eksos gass fra motoren og gjenoppretter driften av hele systemet.

Art.-Nr.	Beskrivelse	€		
TR1136.P.01	5 L Tank (1.32 GAL)	-	02	168



DPF Rinse

Diesel Partikkel Filter Rinse

Hva er det?

Spesiell væske som skyller diesel partikkelfilter etter rengjøring. Takket være sin spesielle kjemiske formulering, kan dette produktet kan trenge dypt inn i partikkelfilter, som enkelt fjerner karbon og sot rester som hindrer normal passering av eksos gass fra motoren og gjenoppretter driften av hele systemet.

Art.-Nr.	Beskrivelse	€		
TR1137.P.01	5 L Tank (1.32 GAL)	-	02	168



DPF Flush Kit

DPF Range Complete Kit

- Kommer i en kasse med DPF Flush pistol, DPF Flush og DPF Rinse.
- Holder til seks regenereringer

Art.-Nr.	Beskrivelse	€		
RK1350	Sett med tre produkter	-	01	-



DPF Flush Gun

Utstyr spesifikt for rengjøring av DPF - FAP

Hva er det?

Spesifikt utstyr som fungerer med trykkluft, designet for rengjøring av diesel partikkelfilter filter. Utstyrt med lett utskiftbare sonder, rigid og en å intervensere på alle modeller av partikkelfilter.

Fordeler

- Gummi håndtak
- utskiftbare stive sonde
- utskiftbare fleksibel sonde
- Tilkobling for trykkluft med kuleventil
- FKM pakninger motstandsdyktig også for de mest aggressive væske
- Riisan PA11 slangen tåler også mest aggressive væske

Art.-Nr.	Beskrivelse	€		
RP1052.01	DPF Flush Gun	-	01	-





One Shot Nitrogen Kit - med Nitrogen tilsatt 5% hydrogen

Leveres med:

- Manometer/regulator med slange
- 950 CC Nitrogen med tilsatt 5% hydrogen
- 110 bar inn / maks. 10 bar ut
- Slange lengde 200 cm
- LP hurtigadapter R134a / R1234yf
- Koffert

BG1062+MN1020.01+RP1009.01+RP1071+RP1057.01

Art.-Nr.	€		
RK1458	-	12	-



Nitrogen Pressure Regulator for Mini Cylinders

It is a pressure regulator for mini cylinders that contain nitrogen or nitrogen/hydrogen.

Technical features:

Inlet pressure: max 110 bar.
 Outlet pressure: max 10 bar.
 Hose length: 200 cm.
 Fitting: 1/4 SAE swivel ball valve.

Art.-Nr.	Art.-Nr.	€		
MN1020.01		-	01	-



N₂ (Nitrogen) and N₂H₂ (Nitrogen-Hydrogen) Cylinder

Disposable cylinders filled to a pressure of 110 bar.

Art.-Nr.	Beskrivelse	€		
BG1062.01	N ₂ H ₂ (Nitrogen-Hydrogen) cylinder 950cc	-	12	-

Art.-Nr.	Beskrivelse	€		
RP1061.01	W24,32 x 1"1/4 - DIN477 nr. 10 (DE)	-	01	-



□ Nitrogen trykkregulator

Technical features:

- Inlet pressure: max 200 bar.
- Outlet pressure: max 60 bar.
- 1/4 SAE male fitting.

Art.-Nr.	Beskrivelse	€		
RK1280.DE	Connection W24,32 x 1"1/4 - DIN477 nr. 10 (DE)	-	01	-



□ SealUp

Gjengetting for A/C skjøter

Hva er det?

SEALUP er en gjengetting for skrudedde skjøter i A/C systemer. SEALUP danner en kjemisk resistent film. Den forblir fleksibel, og fordeler seg utover gjengeflaten. Ideell på plast og metall motstår ekstreme vibrasjoner. Arbeids temperatur fra -90 til + 20° Motstandsdyktig både i vakuum og trykk opp til 500 bar / 7250 Psi.

Hvordan virker det?

SEALUP påført gjenger, flenser og pakninger fester seg til overflater og former en langvarig fleksibel forsegling. Det forhindrer lekkasjer fra rør skjøter, beslag og bolter. Den motstår kontakt til flere kjemikalier inkludert kjølegasser, drivstoff gasser, smøremidler, brensel, løsemidler og industrielle gasser.

Fordeler

- Forhindrer lekkasjer.
- Tillater gjenåpning uten problemer.
- Enkel og fjerne.

Art.-Nr.	Beskrivelse	€		
TR1157.Y.01	50 mL Tube	-	30	5400



□ Thor

Tetningsmasse fjerner

Hva er det?

THOR er en spesiell rask og effektiv fungerende kjemisk produkt, utviklet for å fjerne rester av tetningsmasse fra overflater.

Hvordan virker det?

Spray THOR direkte på overflaten der tetningsmasse er, vent to minutter og rengjør med en klut.

Art.-Nr.	Beskrivelse	€		
TR1013.J.01	200 mL Can	-	24	2376



R134a Errecom hurtigkoblinger som møter SAE J639

Art.-Nr.	Beskrivelse		€
RA1053.S1	1/4 SAE - High Pressure Port	01	-
RA1054.S1	1/4 SAE - Low Pressure Port	01	-
RA1055.S1	M14x1.5 - High Pressure Port	01	-
RA1056.S1	M14x1.5 - Low Pressure Port	01	-



R1234yf Errecom hurtigkoblinger som møter J2888

Art.-Nr.	Beskrivelse		€
RA1050.S1	M12x1.5 High Pressure Port	01	-
RA1051.S1	M12x1.5 Low Pressure Port	01	-



Serviceport adapter HP Rød

Specific for A/C System of: BMW - FORD - MERCEDES - VOLVO - JAGUAR

Art.-Nr.	Beskrivelse		€
RA1018.01	R134a High Pressure Port	01	-
RA1072.01	R134a Low Pressure Port	01	-
RA1073.01	R1234yf High Pressure Port	01	-
RA1074.01	R1234yf Low Pressure Port	01	-



Renault adapter fra modell år 2003

Specific for Vehicles without Low Side Port

Art.-Nr.		€
RK1208	01	-



Retrofit adaptere

Art.-Nr.	Beskrivelse		€
RA1070.S1	M12x1.5 High Pressure Port (A)	01	-
RA1071.S1	M12x1.5 Low Pressure Port (B)	01	-
RA1075.S1	1/4 SAE Male - High Pressure Port (C)	01	-
RA1076.S1	1/4 SAE Male - Low Pressure Port (D)	01	-



Reduksjon hurtigkobling

Art.-Nr.	Description		€
RP1008.01	3/8 SAE (M) X 1/4 SAE (F) (A)	05	-
RP1009.01	1/4 SAE (M) X 1/2 ACME (F) (B)	05	-
RP1017.01	1/2 ACME (M) X 1/4 SAE (F) (C)	05	-
RP1016.01	M14 x 1,5 (M) X 1/4 SAE (M) (D)	05	-
RP1057.01	M12 x 1,5 (M) X 1/4 SAE (M) (D)	05	-
RP1063.01	M14x1,5 (F) X M12x1,5 (M) (E)	01	-
RP1064.01	M14x1,5 (F) X 1/4 SAE (M) (F)	01	-

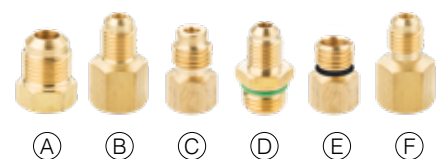

06

Continental R134a fylleslanger SAE J2196 - SAEJ2888



CONTINENTAL R134a fylleslanger SAE J2196 - J2888 med M14x1, tilkobling

Art.-Nr.	Beskrivelse	Cm		€
TB7605B	LP slange blå	300	01	-
TB7605R	HP slange rød	300	01	-

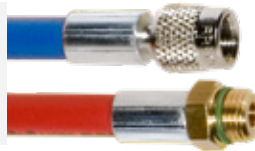

Continental fylleslanger SAE J2196 og SAE J2888

Art.-Nr.	Beskrivelse	Cm		€
TB7601B	LP slange blå	300	01	-
TB7601R	HP slange rød	300	01	-

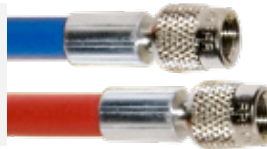

CONTINENTAL R1234yf fylleslanger, SAE J2196 - J2888 med M12x1,5 tilkobling.

Art.-Nr.	Beskrivelse	Cm		€
TB7279B	LP slange blå	300	01	-
TB7279R	HP slange rød	300	01	-

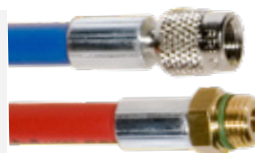

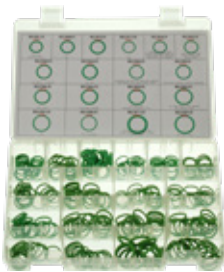

RG1022.01	RG1023.01	RG1024.01	RG1004.01	RG1020.01	RG1014.01	RG1025.01
RG1026.01	RG1021.01	RG1027.01	RG1080.01	RG1049.01	RG1013.01	
RG1082.01	RG1050.01	RG1031.01	RG1057.01	RG1058.01	RG1032.01	
RG1071.01	RG1033.01	RG1039.01	RG1066.01	RG1059.01		

O-ring sett for Asiatiske og Europeiske biler

Art.-Nr.	Beskrivelse		€
RK1166	10 O-Rings per code (Totalt 240 O ringer)	01	-



RG1073.01 05 pcs	RG1074.01 05 pcs	RG1075.01 05 pcs	RG1076.01 06 pcs
RG1077.01 06 pcs	RG1078.01 06 pcs	RG1079.01 06 pcs	RG1080.01 06 pcs
RG1081.01 03 pcs	RG1082.01 03 pcs	RG1083.01 03 pcs	RG1084.01 03 pcs

OEM O-ring sett spesial. Alfa Romeo, Daf, Fiat, PSA, Renault, Volvo

Art.-Nr.	Beskrivelse		€
RK1140	O-ring sett for Asiatiske og Europeiske biler	01	-



RL1006.01 01 pc	RG2001.01 10 pcs	RL1002.01 01 pc
RL1007.01 01 pc	RG2002.01 10 pcs	RL1003.01 01 pc
RL1008.01 01 pc	RG2003.01 10 pcs	RL1004.01 01 pc
RL1009.01 01 pc	RG2004.01 10 pcs	RL1005.01 01 pc

Springlock servicesett. Fjærlåser, O-ringer & verktøy. Også for V.A.G. & Opel

Art.-Nr.	Beskrivelse		€
RK1150	Springlock servicesett.	01	-

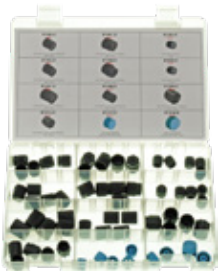

RT1000.01 05 pcs	RT1001.01 05 pcs	RT1002.01 05 pcs
RT1003.01 05 pcs	RT1004.01 05 pcs	RT1005.01 05 pcs
RT1007.01 05 pcs	RT1008.01 05 pcs	RT1009.01 05 pcs
RT1010.01 05 pcs	RT1017.01 05 pcs	RT1018.01 05 pcs

Ventil hetter

Kan også bruke Art. - Nr. RK1080

Art.-Nr.	Beskrivelse		€
RK1052	Ventil hetter	01	-



RV3001.01 03 pcs	RV3002.01 03 pcs	RV3003.01 03 pcs
RV3004.01 03 pcs	RV3005.01 03 pcs	RV3006.01 03 pcs
RV3007.01 03 pcs	RV3008.01 03 pcs	RV3009.01 03 pcs
RV3010.01 03 pcs		

30 stk orifice i sett

Art.-Nr.	Beskrivelse		€
RK1051	30 stk orifice i sett	01	-















RV1001.01 01 pc	RV1004.01 01 pc	RV1005.01 01 pc
RV1006.01 01 pc	RV2025.01 01 pc	RV2030.01 01 pc
RT1044.01 01 pc	RL1001.01 01 pc	

NYHET











Art.-Nr.	Beskrivelse		€
RK1462	Nåleventil kit R1234yf	01	-



 RG2005.01 03 pcs	 RG2006.01 03 pcs	 RG2007.01 03 pcs
 RG2008.01 03 pcs	 RG2009.01 03 pcs	 RG2010.01 03 pcs
 RG2011.01 03 pcs	 RG2012.01 03 pcs	 RG2013.01 03 pcs
 RG2014.01 03 pcs	 RG2015.01 03 pcs	 RG2016.01 03 pcs

A/C kompressor pakninger























Art.-Nr.	Beskrivelse		€
RK1053	A/C kompressor pakninger	01	-

 RG2009.01 01 pcs	 RG2010.01 01 pcs	 RG2011.01 01 pcs	 RG2012.01 01 pcs	 RG2013.01 01 pcs	 RG2014.01 01 pcs	 RG2015.01 01 pcs	 RG2016.01 01 pcs	 RL1014.01 01 pcs
 RL1022.01 01 pcs	 RL1018.01 01 pcs							

Compressor Guard Kit ver. 3.

Art.-Nr.	Beskrivelse		€
RK1033	Kompressor Guard	01	-













 RV1001.01 05 pcs	 RV1002.01 05 pcs	 RV1003.01 05 pcs	 RV1004.01 05 pcs	 RV1005.01 05 pcs	 RV1006.01 05 pcs
 RV2010.01 02 pcs	 RV2012.01 02 pcs	 RV2014.01 02 pcs	 RV2015.01 02 pcs		
 RT1000.01 05 pcs	 RT1001.01 05 pcs	 RT1003.01 05 pcs	 RT1004.01 05 pcs	 RT1017.01 05 pcs	 RT1018.01 05 pcs
 RT1007.01 05 pcs	 RT1008.01 05 pcs	 RT1010.01 05 pcs	 RT1010.01 05 pcs	 RT1002.01 05 pcs	 RT1009.01 05 pcs

Sett med ventiler, hetter og serviceporter

Art.-Nr.	Beskrivelse		€
RK1080	Sett med ventiler, hetter og serviceporter	01	-



 RV1001.01 (10 pcs)	 RV1002.01 (05 pcs)	 RV1003.01 (05 pcs)
 RV1004.01 (05 pcs)	 RV1005.01 (05 pcs)	 RV1006.01 (05 pcs)
 RV1010.01 (05 pcs)	 RV1011.01 (05 pcs)	 RV1012.01 (05 pcs)
 RL1001.01		

Ventil sett m/verktøy

Art.-Nr.	Beskrivelse		€
RK1331	Ventil sett m/verktøy	01	-



Verktøy sett for fjerning & montering av Orifice Tube (struperør)









































Art.-Nr.	Beskrivelse		€
RK1116	Verktøy sett for fjerning & montering av Orifice Tube (struperør)	01	-



Nålevent værktøy

Art.-Nr.	Beskrivelse		€
RL1001.01	Nålevent værktøy	01	-

Green HNBR O-Ring Kit

<p>Art.-Nr.  €</p> <p>RG1022.25 25 -</p>  <p>FORD - LEXUS - RENAULT SAAB - SUBARU - TOYOTA - VOLVO</p>	<p>Art.-Nr.  €</p> <p>RG1001.25 25 -</p>  <p>RENAULT - ROVER</p>	<p>Art.-Nr.  €</p> <p>RG1023.25 25 -</p>  <p>FORD - PORSCHE RENAULT - ROVER - SUBARU</p>	<p>Art.-Nr.  €</p> <p>RG1010.25 25 -</p>  <p>JAGUAR - RENAULT - SUBARU</p>
<p>Art.-Nr.  €</p> <p>RG1024.25 25 -</p>  <p>ALFA ROMEO - FIAT - LANCIA</p>	<p>Art.-Nr.  €</p> <p>RG1004.25 25 -</p>  <p>ALFA ROMEO - FIAT - LANCIA - FORD LEXUS - RENAULT SAAB - SUBARU - TOYOTA - VOLVO</p>	<p>Art.-Nr.  €</p> <p>RG1040.25 25 -</p>  <p>ALFA ROMEO - BMW - LEXUS OPEL - TOYOTA</p>	<p>Art.-Nr.  €</p> <p>RG1020.25 25 -</p>  <p>ALFA ROMEO - FIAT - LANCIA FORD - ROVER</p>
<p>Art.-Nr.  €</p> <p>RG1065.25 25 -</p>  <p>OPEL</p>	<p>Art.-Nr.  €</p> <p>RG1014.25 25 -</p>  <p>ALFA ROMEO - HONDA - JAGUAR ROVER - TOYOTA</p>	<p>Art.-Nr.  €</p> <p>RG1041.25 25 -</p>  <p>FORD - ROVER</p>	<p>Art.-Nr.  €</p> <p>RG1042.25 25 -</p>  <p>ROVER</p>
<p>Art.-Nr.  €</p> <p>RG1009.25 25 -</p>  <p>FORD</p>	<p>Art.-Nr.  €</p> <p>RG1025.25 01 -</p>  <p>ALFA ROMEO - AUDI - BMW - CITROEN FIAT - FORD - JAGUAR - LEXUS MERCEDES - OPEL - PEUGEOT - PORSCHE RENAULT - ROVER - SAAB - SUBARU TOYOTA - VOLVO - VOLKSWAGEN</p>	<p>Art.-Nr.  €</p> <p>RG1007.25 25 -</p>  <p>JAGUAR</p>	<p>Art.-Nr.  €</p> <p>RG1026.25 25 -</p>  <p>AUDI - FORD - VOLKSWAGEN</p>
<p>Art.-Nr.  €</p> <p>RG1038.25 25 -</p>  <p>FIAT - FORD</p>	<p>Art.-Nr.  €</p> <p>RG1011.25 25 -</p>  <p>BMW</p>	<p>Art.-Nr.  €</p> <p>RG1002.25 25 -</p>  <p>JAGUAR - SAAB - VOLVO</p>	<p>Art.-Nr.  €</p> <p>RG1005.25 25 -</p>  <p>JAGUAR</p>
<p>Art.-Nr.  €</p> <p>RG1021.25 25 -</p>  <p>AUDI - MERCEDES - OPEL - PORSCHE SAAB - SUBARU - VOLVO - VOLKSWAGEN</p>	<p>Art.-Nr.  €</p> <p>RG1027.25 25 -</p>  <p>ALFA ROMEO - BMW - FIAT - FORD MERCEDES - OPEL - RENAULT</p>	<p>Art.-Nr.  €</p> <p>RG1047.25 25 -</p>  <p>OPEL - ROVER</p>	<p>Art.-Nr.  €</p> <p>RG1060.25 25 -</p>  <p>BMW - FORD - OPEL SAAB - VOLVO</p>
<p>Art.-Nr.  €</p> <p>RG1067.25 25 -</p>  <p>OPEL</p>	<p>Art.-Nr.  €</p> <p>RG1048.25 25 -</p>  <p>OPEL</p>	<p>Art.-Nr.  €</p> <p>RG1028.25 25 -</p>  <p>FORD</p>	<p>Art.-Nr.  €</p> <p>RG1013.25 25 -</p>  <p>ALFA ROMEO - AUDI - BMW - CITROEN FIAT - FORD - JAGUAR - LEXUS MERCEDES - OPEL - PEUGEOT - PORSCHE RENAULT - ROVER - SAAB - SUBARU TOYOTA - VOLVO - VOLKSWAGEN</p>

Images represented in 1:1 Scale. The O-Rings dimensions from pg. 53 to 55 are real to allow the technician to immediately identify the needed spare parts.























Green HNBR O-Ring Kit

<p>Art.-Nr.  €</p> <p>RG1049.25 25 -</p>  <p>ALFA ROMEO - FIAT - FORD HONDA - JAGUAR - LEXUS ROVER - TOYOTA</p>	<p>Art.-Nr.  €</p> <p>RG1070.25 25 -</p>  <p>OPEL</p>	<p>Art.-Nr.  €</p> <p>RG1062.25 25 -</p>  <p>BMW - LEXUS - OPEL - TOYOTA</p>	<p>Art.-Nr.  €</p> <p>RG1006.25 25 -</p>  <p>JAGUAR</p>
<p>Art.-Nr.  €</p> <p>RG1043.25 25 -</p>  <p>FORD - ROVER</p>	<p>Art.-Nr.  €</p> <p>RG1056.25 25 -</p>  <p>JAGUAR</p>	<p>Art.-Nr.  €</p> <p>RG1003.25 25 -</p>  <p>FORD</p>	<p>Art.-Nr.  €</p> <p>RG1015.25 25 -</p>  <p>SAAB - VOLVO</p>
<p>Art.-Nr.  €</p> <p>RG1030.25 25 -</p>  <p>FIAT - FORD</p>	<p>Art.-Nr.  €</p> <p>RG1008.25 25 -</p>  <p>JAGUAR</p>	<p>Art.-Nr.  €</p> <p>RG1050.25 25 -</p>  <p>ALFA ROMEO - FIAT LANCIA - SUBARU</p>	<p>Art.-Nr.  €</p> <p>RG1035.25 25 -</p>  <p>CITROEN - LEXUS PEUGEOT - TOYOTA</p>
<p>Art.-Nr.  €</p> <p>RG1045.25 25 -</p>  <p>LEXUS - HONDA - ROVER - TOYOTA</p>	<p>Art.-Nr.  €</p> <p>RG1031.25 25 -</p>  <p>ALFA ROMEO - AUDI - BMW CITROEN - FIAT - FORD - JAGUAR - LEXUS MERCEDES - OPEL - PEUGEOT - PORSCHE RENAULT - ROVER - SAAB - SUBARU TOYOTA - VOLVO - VOLKSWAGEN</p>	<p>Art.-Nr.  €</p> <p>RG1029.25 25 -</p>  <p>MERCEDES - PORSCHE</p>	<p>Art.-Nr.  €</p> <p>RG1057.25 25 -</p>  <p>ALFA ROMEO - BMW OPEL - ROVER</p>
<p>Art.-Nr.  €</p> <p>RG1069.25 25 -</p>  <p>OPEL - SAAB - VOLVO</p>	<p>Art.-Nr.  €</p> <p>RG1051.25 25 -</p>  <p>BMW - FORD - OPEL - SAAB - VOLVO</p>	<p>Art.-Nr.  €</p> <p>RG1058.25 25 -</p>  <p>OPEL</p>	<p>Art.-Nr.  €</p> <p>RG1072.25 25 -</p>  <p>OPEL</p>
<p>Art.-Nr.  €</p> <p>RG1017.25 25 -</p>  <p>FORD</p>	<p>Art.-Nr.  €</p> <p>RG1036.25 25 -</p>  <p>ALFA ROMEO - AUDI - BMW CITROEN - FIAT - FORD - JAGUAR - LEXUS MERCEDES - OPEL - PEUGEOT - PORSCHE RENAULT - ROVER - SAAB - SUBARU TOYOTA - VOLVO - VOLKSWAGEN</p>	<p>Art.-Nr.  €</p> <p>RG1032.25 25 -</p>  <p>ALFA ROMEO - FIAT - FORD - HONDA - JAGUAR - LEXUS - ROVER - TOYOTA</p>	<p>Art.-Nr.  €</p> <p>RG1044.25 25 -</p>  <p>AUDI - RENAULT - VOLKSWAGEN</p>

Green HNBR O-Ring Kit

<p>Art.-Nr.  €</p> <p>RG1063.25 25 -</p>  <p>FIAT - OPEL</p>	<p>Art.-Nr.  €</p> <p>RG1033.25 25 -</p>  <p>ALFA ROMEO - AUDI - BMW - FIAT LEXUS - MERCEDES - OPEL - PEUGEOT PORSCHE - RENAULT - ROVER - SAAB SUBARU - TOYOTA - VOLVO VOLKSWAGEN</p>	<p>Art.-Nr.  €</p> <p>RG1039.25 25 -</p>  <p>AUDI - HONDA - MERCEDES - PORSCHE - VOLKSWAGEN</p>	<p>Art.-Nr.  €</p> <p>RG1046.25 25 -</p>  <p>SAAB - VOLVO</p>
<p>Art.-Nr.  €</p> <p>RG1066.25 25 -</p>  <p>ALFA ROMEO - MERCEDES</p>	<p>Art.-Nr.  €</p> <p>RG1052.25 25 -</p>  <p>FIAT - FORD - LEXUS MERCEDES - OPEL - RENAULT - TOYOTA</p>	<p>Art.-Nr.  €</p> <p>RG1053.25 25 -</p>  <p>FIAT - FORD - HONDA - LEXUS - MERCEDES OPEL - PORSCHE - TOYOTA</p>	<p>Art.-Nr.  €</p> <p>RG1037.25 25 -</p>  <p>OPEL</p>
<p>Art.-Nr.  €</p> <p>RG1034.25 25 -</p>  <p>AUDI - VOLKSWAGEN</p>	<p>Art.-Nr.  €</p> <p>RG1071.25 25 -</p>  <p>ALFA ROMEO - AUDI - CITROEN FORD - JAGUAR - LEXUS - MERCEDES OPEL - PEUGEOT - ROVER - TOYOTA</p>	<p>Art.-Nr.  €</p> <p>RG1059.25 25 -</p>  <p>OPEL - SAAB - VOLVO</p>	<p>Art.-Nr.  €</p> <p>RG1054.25 25 -</p>  <p>SAAB - VOLVO</p>
<p>Art.-Nr.  €</p> <p>RG1064.25 25 -</p>  <p>BMW</p>	<p>Art.-Nr.  €</p> <p>RG1068.25 25 -</p>  <p>MERCEDES</p>	<p>Art.-Nr.  €</p> <p>RG1055.25 25 -</p>  <p>AUDI - OPEL - VOLKSWAGEN</p>	

Special Gaskets Kit

<p>Art.-Nr.  €</p> <p>RG1073.25 25 -</p>  <p>OEM FIAT 0010551983</p>	<p>Art.-Nr.  €</p> <p>RG1074.25 25 -</p>  <p>OEM FIAT 0010552083</p>	<p>Art.-Nr.  €</p> <p>RG1075.25 25 -</p>  <p>OEM FIAT 0010552183</p>	<p>Art.-Nr.  €</p> <p>RG1076.25 25 -</p>  <p>OEM PSA 6460P0</p>
<p>Art.-Nr.  €</p> <p>RG1077.25 25 -</p>  <p>OEM PSA 6460P1</p>	<p>Art.-Nr.  €</p> <p>RG1078.25 25 -</p>  <p>OEM RENAULT #1 - 7701207274 (KIT)</p>	<p>Art.-Nr.  €</p> <p>RG1079.25 25 -</p>  <p>RG1079.25 OEM RENAULT #2 - 7701207274 (KIT)</p>	<p>Art.-Nr.  €</p> <p>RG1080.25 25 -</p>  <p>RG1080.25 OEM RENAULT #3 - 7701207274 (KIT)</p>
<p>Art.-Nr.  €</p> <p>RG1081.05 05 -</p>  <p>DAF - FIAT PSA RENAULT VOLVO Ø 7,50 x H 8,80</p>	<p>Art.-Nr.  €</p> <p>RG1082.05 05 -</p>  <p>DAF - FIAT PSA RENAULT VOLVO Ø 11 x H 8,80</p>	<p>Art.-Nr.  €</p> <p>RG1083.05 05 -</p>  <p>DAF - FIAT PSA RENAULT VOLVO Ø 14 x H 8,80</p>	<p>Art.-Nr.  €</p> <p>RG1084.05 05 -</p>  <p>DAF - FIAT PSA RENAULT VOLVO Ø 17,30 x H 8,80</p>



□ A/C System Service Port

<p>Art.-Nr.  €</p> <p>RV2010.05 05 -</p>  <p>HIGH SIDE PORT WITH STANDARD VALVE CORE (BMW - MERCEDES - MINI - ROVER)</p>	<p>Art.-Nr.  €</p> <p>RV2011.05 05 -</p>  <p>HIGH SIDE PORT WITH LARGE VALVE CORE (BMW - MERCEDES - MINI - ROVER)</p>	<p>Art.-Nr.  €</p> <p>RV2012.05 05 -</p>  <p>LOW SIDE PORT WITH STANDARD VALVE CORE (BMW - MERCEDES - MINI - ROVER)</p>	<p>Art.-Nr.  €</p> <p>RV2013.05 05 -</p>  <p>LOW SIDE PORT WITH LARGE VALVE CORE (BMW - MERCEDES - MINI - ROVER)</p>
<p>Art.-Nr.  €</p> <p>RV2014.05 05 -</p>  <p>HIGH SIDE PORT WITH STANDARD VALVE CORE (AUDI - FORD - OPEL - SEAT - SKODA - VW)</p>	<p>Art.-Nr.  €</p> <p>RV2015.05 05 -</p>  <p>LOW SIDE PORT WITH STANDARD VALVE CORE (AUDI - FORD - OPEL - SEAT - SKODA - VW)</p>	<p>Art.-Nr.  €</p> <p>RV2016.05 05 -</p>  <p>HIGH SIDE PORT TO SOLDER (STANDARD VALVE CORE)</p>	<p>Art.-Nr.  €</p> <p>RV2017.05 05 -</p>  <p>LOW SIDE PORT TO SOLDER (STANDARD VALVE CORE)</p>
<p>Art.-Nr.  €</p> <p>RV2029.05 05 -</p>  <p>HIGH PRESSURE R1234yf REPLACEMENT SERVICE PORT</p>	<p>Art.-Nr.  €</p> <p>RV2030.05 05 -</p>  <p>LOW PRESSURE R1234yf REPLACEMENT SERVICE PORT</p>		









□ Complete A/C Service Port Caps

<p>Art.-Nr.  €</p> <p>RT1000.05 05 -</p>  <p>M9 X 1 - LOW SIDE R134a SERVICE PORT CAP</p>	<p>Art.-Nr.  €</p> <p>RT1004.05 05 -</p>  <p>M10 x 1,25 HIGH SIDE R134a SERVICE PORT CAP</p>	<p>Art.-Nr.  €</p> <p>RT1003.05 05 -</p>  <p>M8 x 1 LOW SIDE R134a SERVICE PORT CAP</p>	<p>Art.-Nr.  €</p> <p>RT1001.05 05 -</p>  <p>M8 x 1 HIGH SIDE R134a SERVICE PORT CAP</p>
<p>Art.-Nr.  €</p> <p>RT1008.05 05 -</p>  <p>M9 x 1 LOW SIDE R134a SERVICE PORT CAP</p>	<p>Art.-Nr.  €</p> <p>RT1007.05 05 -</p>  <p>M10 x 1 HIGH SIDE R134a SERVICE PORT CAP</p>	<p>Art.-Nr.  €</p> <p>RT1010.05 05 -</p>  <p>M8 x 1 LOW SIDE R134a SERVICE PORT CAP</p>	<p>Art.-Nr.  €</p> <p>RT1009.05 05 -</p>  <p>M10 x 1 HIGH SIDE R134a SERVICE PORT CAP</p>
<p>Art.-Nr.  €</p> <p>RT1017.05 05 -</p>  <p>JAPANESE CARS LOW SIDE R134a SERVICE PORT CAP</p>	<p>Art.-Nr.  €</p> <p>RT1018.05 05 -</p>  <p>JAPANESE CARS HIGH SIDE R134a SERVICE PORT CAP</p>	<p>Art.-Nr.  €</p> <p>RT1002.05 05 -</p>  <p>1/4 SAE SERVICE PORT PLASTIC CAP</p>	<p>Art.-Nr.  €</p> <p>RT1005.05 05 -</p>  <p>3/16 SAE SERVICE PORT PLASTIC CAP</p>
<p>Art.-Nr.  €</p> <p>RT1202.05 05 -</p>  <p>5/16 SAE SERVICE PORT BRASS CAP</p>	<p>Art.-Nr.  €</p> <p>RT1302.05 05 -</p>  <p>1/4 SAE SERVICE PORT BRASS CAP WITH TOOL</p>	<p>Art.-Nr.  €</p> <p>RT1402.05 05 -</p>  <p>5/16 SAE SERVICE PORT BRASS CAP WITH TOOL</p>	<p>Art.-Nr.  €</p> <p>RT1044.05 05 -</p>  <p>HIGH/LOW PRESSURE R1234yf PORT CAP</p>

□ A/C Compressor Caps

<p>Art.-Nr.  €</p> <p>RT1021.05 05 -</p>  <p>FOR GM COMPRESSOR 3/4" - 16 UNF PLASTIC CAP</p>	<p>Art.-Nr.  €</p> <p>RT1022.05 05 -</p>  <p>FOR GM COMPRESSOR 7/8" - 14 UNF PLASTIC CAP</p>	<p>Art.-Nr.  €</p> <p>RT1025.05 05 -</p>  <p>FOR GM COMPRESSOR 1 1/16" - 14 UNF PLASTIC CAP</p>	<p>Art.-Nr.  €</p> <p>RT1024.05 05 -</p>  <p>FOR GM COMPRESSOR 1" - 14 UNF PLASTIC CAP</p>
------------------------------------------------------------------------------------------------------------------------------------------------------------------------------------------------------------------------------------------------------------------------	------------------------------------------------------------------------------------------------------------------------------------------------------------------------------------------------------------------------------------------------------------------------	---------------------------------------------------------------------------------------------------------------------------------------------------------------------------------------------------------------------------------------------------------------------------	--------------------------------------------------------------------------------------------------------------------------------------------------------------------------------------------------------------------------------------------------------------------------













□ A/C System Valve Core

Art.-Nr.	🛠️	€	Art.-Nr.	🛠️	€	Art.-Nr.	🛠️	€	Art.-Nr.	🛠️	€	Art.-Nr.	🛠️	€
RV1001.25	25	-	RV1002.05	05	-	RV1003.05	05	-	RV1004.05	05	-	RV1005.05	05	-
														
STANDARD VALVE CORE			VALVE CORE M6 x 1 GM - PORSCHE A/C SYSTEMS			VALVE CORE M8 x 1 PEUGEOT - RENAULT - CITROEN - VOLVO			VALVE CORE M6 x 0.75 DENSO A/C SYSTEM			VALVE CORE M10 x 0.75 BUICK A/C SYSTEM		
RV1006.05	05	-	RV1010.05	05	-	RV1011.05	05	-	RV1012.05	05	-			
														
VALVE CORE M8 x 1 BUICK A/C SYSTEM			VALVE CORE M6 x 0.75 DENSO A/C SYSTEM 2011			VALVE CORE M8 x 1 BMW - MINI - ROVER - MERCEDES 2011			VALVE CORE M8 x 1 AUDI - FORD - OPEL - SKODA - VW 2011					

□ Retrofit Adapters

Art.-Nr.	🛠️	€	Art.-Nr.	🛠️	€	Art.-Nr.	🛠️	€	Art.-Nr.	🛠️	€
RF1000.05	05	-	RF1001.05	05	-	RF1019.05	05	-	RF1015.05	05	-
											
1/4 SAE BRASS HIGH SIDE PORT			1/4 SAE BRASS LOW SIDE PORT			3/16 SAE ALUMINIUM HIGH SIDE PORT			90° 1/4 SAE BRASS HIGH SIDE PORT		
RF1017.05	05	-	RF1012.05	05	-	RF1014.05	05	-			
											
90° 3/16 SAE BRASS HIGH SIDE PORT			1/4 SAE ALUMINIUM HIGH SIDE PORT WITHOUT VALVE CORE			3/16 SAE ALUMINIUM HIGH SIDE PORT WITHOUT VALVE CORE					

□ A/C Compressor Gaskets

Art.-Nr.	🛠️	€	Art.-Nr.	🛠️	€	Art.-Nr.	🛠️	€	Art.-Nr.	🛠️	€
RG2005.05	05	-	RG2006.05	05	-	RG2007.05	05	-	RG2008.05	05	-
											
FOR GM COMPRESSOR Ø8 mm (IN) x Ø16,30 mm (OUT)			FOR GM COMPRESSOR Ø11 mm (IN) x Ø19,50 mm (OUT)			FOR GM COMPRESSOR Ø15 mm (IN) x Ø23,60 mm (OUT)			FOR GM COMPRESSOR Ø17 mm (IN) x Ø25,50 mm (OUT)		
RG2009.05	05	-	RG2010.05	05	-	RG2011.05	05	-	RG2012.05	05	-
											
FOR 5/8 GM COMPRESSOR Ø15,00 mm (IN) x Ø28,00 mm (OUT)			FOR 3/4 GM COMPRESSOR Ø17,70 mm (IN) x Ø31,60 mm (OUT)			FOR HARRISON COMPRESSOR Giallo Ø15,70 mm (IN) X Ø33,55 mm (OUT)			FOR HARRISON & GM COMPRESSOR Black Ø15,20 mm (IN) X Ø29,60 mm (OUT)		
RG2013.05	05	-	RG2014.05	05	-	RG2015.05	05	-	RG2016.05	05	-
											
FOR HARRISON & GM COMPRESSOR Green Ø16,60 mm (IN) X Ø30,00 mm (OUT)			FOR HARRISON & GM COMPRESSOR Rosso Ø15,70 mm (IN) X Ø30,00 mm (OUT)			FOR HARRISON COMPRESSOR SHORT ALUMINIUM PILOT			FOR HARRISON COMPRESSOR LONG ALUMINIUM PILOT		

Springlock Connections

<p>Art.-Nr.  €</p> <p>RG2001.10 10 -</p>  <p>G6 SPRINGLOCK</p>	<p>Art.-Nr.  €</p> <p>RG2002.10 10 -</p>  <p>G8 SPRINGLOCK</p>	<p>Art.-Nr.  €</p> <p>RG2003.10 10 -</p>  <p>G10 SPRINGLOCK</p>	<p>Art.-Nr.  €</p> <p>RG2004.10 10 -</p>  <p>G12 SPRINGLOCK</p>
<p>Art.-Nr.  €</p> <p>RL1002.01 01 -</p>  <p>G6 RED SPRINGLOCK TOOL</p>	<p>Art.-Nr.  €</p> <p>RL1003.01 01 -</p>  <p>G8 BLUE SPRINGLOCK TOOL</p>	<p>Art.-Nr.  €</p> <p>RL1004.01 01 -</p>  <p>G10 BLACK SPRINGLOCK TOOL</p>	<p>Art.-Nr.  €</p> <p>RL1005.01 01 -</p>  <p>G12 WHITE SPRINGLOCK TOOL</p>
<p>Art.-Nr.  €</p> <p>RL1006.01 01 -</p>  <p>LOW-PRESSURE GREY SPRINGLOCK TOOL (OPEL - GENERAL MOTORS)</p>	<p>Art.-Nr.  €</p> <p>RL1007.01 01 -</p>  <p>HIGH-PRESSURE RED SPRINGLOCK TOOL (OPEL - GENERAL MOTORS)</p>	<p>Art.-Nr.  €</p> <p>RL1008.01 01 -</p>  <p>LOW-PRESSURE BLACK SPRINGLOCK TOOL (AUDI - VW - SKODA)</p>	<p>Art.-Nr.  €</p> <p>RL1009.01 01 -</p>  <p>HIGH-PRESSURE GREEN SPRINGLOCK TOOL (AUDI - VW - SKODA)</p>
<p>Art.-Nr.  €</p> <p>RK1122 01 -</p>  <p>PACK OF 4 SPRINGLOCK TOOLS</p>	<p>Art.-Nr.  €</p> <p>RK1125 01 -</p>  <p>PACK OF 4 SPRINGLOCK TOOLS</p>	<p>Art.-Nr.  €</p> <p>RK1146 01 -</p>  <p>OPEL - GENERAL MOTORS SPRINGLOCK TOOLS KIT</p>	<p>Art.-Nr.  €</p> <p>RK1147 01 -</p>  <p>AUDI - VW - SKODA SPRINGLOCK TOOLS KIT</p>
<p>Art.-Nr.  €</p> <p>RL1018.01 01 -</p>  <p>LOW-PRESSURE SPECIAL SPRINGLOCK TOOL (SMART)</p>	<p>Art.-Nr.  €</p> <p>RL1017.01 01 -</p>  <p>SPECIAL SPRINGLOCK TOOL (MERCEDES W2111)</p>		

Orifice Tubes

<p>Art.-Nr.  €</p> <p>RV3001.03 03 -</p>  <p>ORIFICE TUBE BLUE (FORD)</p>	<p>Art.-Nr.  €</p> <p>RV3002.03 03 -</p>  <p>ORIFICE TUBE GREY (AUDI - VW)</p>	<p>Art.-Nr.  €</p> <p>RV3003.03 03 -</p>  <p>ORIFICE TUBE YELLOW (VOLVO)</p>	<p>Art.-Nr.  €</p> <p>RV3004.03 03 -</p>  <p>ORIFICE TUBE WHITE (AUDI - FIAT - OPEL - VOLVO)</p>
<p>Art.-Nr.  €</p> <p>RV3005.03 03 -</p>  <p>ORIFICE TUBE BROWN (FORD)</p>	<p>Art.-Nr.  €</p> <p>RV3006.03 03 -</p>  <p>ORIFICE TUBE BLACK (OPEL)</p>	<p>Art.-Nr.  €</p> <p>RV3007.03 03 -</p>  <p>ORIFICE TUBE PURPLE (CHRYSLER)</p>	<p>Art.-Nr.  €</p> <p>RV3008.03 03 -</p>  <p>ORIFICE TUBE ORANGE (FORD)</p>
<p>Art.-Nr.  €</p> <p>RV3009.03 03 -</p>  <p>ORIFICE TUBE RED (FORD)</p>	<p>Art.-Nr.  €</p> <p>RV3010.03 03 -</p>  <p>ORIFICE TUBE GREEN (FORD)</p>		

Errecom Academy the know-how of our experts for you

Masterclasses, webinars, and on-site training courses designed to provide AC/R technicians with the specialist training they need to carry out the best system maintenance.

By joining Errecom Academy, you will meet our experts and members of the R&D department, who will share their know-how gained from years of study and research in the field and collaborations with the best OEMs in the industry.

Subscribe here

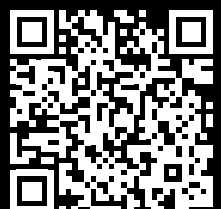



#madeinerrecom

follow us on



info@errecom.it - errecom.com

Distributed by:

ELEKTRO PARTNER A/S

Gilhusveien 7A - 03414 Lierstranda NORWAY

Tel. +4733467370

www.elektropartner.com

norge@elektropartner.com

ERRECOM USA LLC

1900 North Bayshore Drive
1A Suite 129 - 33132 Miami
FLORIDA - USA

ERRECOM SPA

Via Industriale 14
25030 Corzano (Brescia)
ITALY

ERRECOM MDE

Regus Nassima Tower Office 507
Sheikh Zayed Road
Trade Center District
DUBAI